

## PowerLUX- 9W

Reflector+Lens

### Technical Parameters:

Name	PowerLUX10 TW
Light source:	COB
Input Voltage:	AC220~240V 50/60Hz
LED Current:	250mA (36V)
Rated life:	>50,000 hours
Operating temperature:	-20°C~40°C
Storage temperature:	-30°C~60°C
Certificate:	CE/RoHS
Dimmability:	Tunable white
Weight:	0.10KG/pc 11.8KG/CTN 100pcs/CTN 580x300x200mm

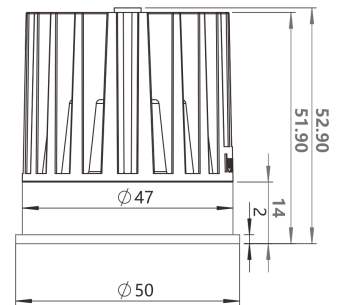
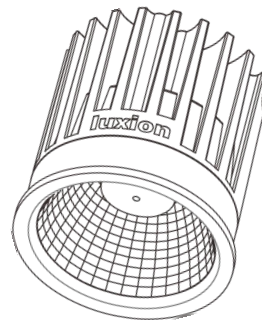

### Ordering Information:

● Dark grey

Power	CRI	Beam Angle	Luminous	CCT	Housing	Part Number
9.0W	>90	▲ 15°	705.3 lm	2700K	●	LUX-30615-M10TW
			844.3 lm	6500K	●	
		▲ 40°	710.9 lm	2700K	●	LUX-30640-M10TW
			854.7 lm	6500K	●	
		▲ 60°	701.3 lm	2700K	●	LUX-30660-M10TW
			848.3 lm	6500K	●	

# PowerLUX10 TW

## Technical Data test pattern

CRI90 15°

2700K

6500K

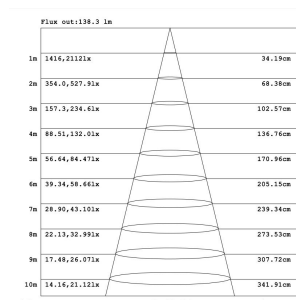
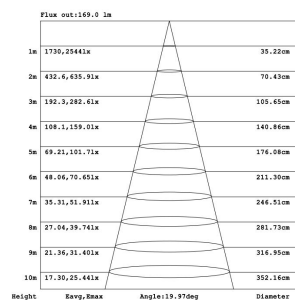
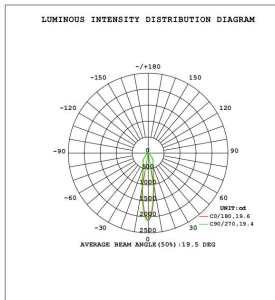

CRI90 40°

2700K

6500K

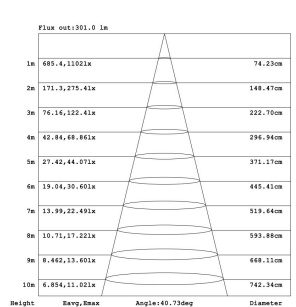
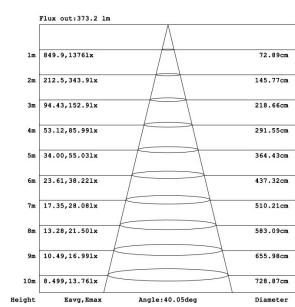
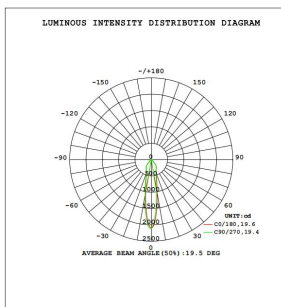

CRI90 60°

2700K

6500K

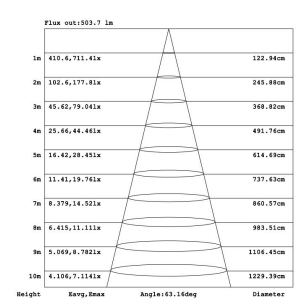
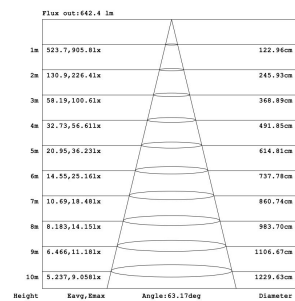
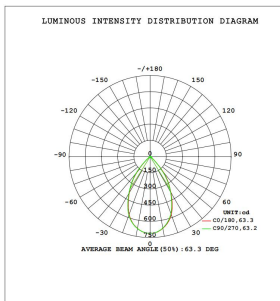

Installation instruction

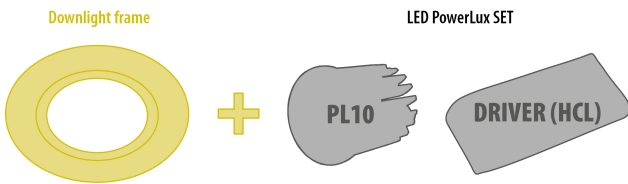

Packaging:



**Box**  
L52\*W52\*H76mm  
1pc/box  
GW: 0.1kg/box



**Middle box**  
L282\*W111\*H82mm  
10pc/box  
GW: 1.05kg/box

**Outer carton**  
L580\*W300\*H200mm  
100pcs/CTN  
GW: 11.8kg/carton

